

IGBT Discrete

V_{CE}	650	V
I_C	160	A
$V_{CE(SAT)} I_C=160A$	1.70	V

Circuit

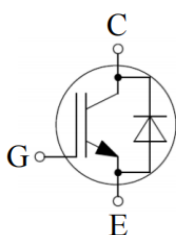

Applications

- Traction Inverter for HEV/EV
- Motor drives
- Auxiliary DC/AC Converter

Features

- High speed smooth switching device for hard & soft switching
- Maximum junction temperature 175°C
- Positive temperature coefficient
- High ruggedness, temperature stable

Maximum Ratings

Parameter	Symbol	Value	Unit
Collector-Emitter Breakdown Voltage	V_{CE}	650	V
DC Collector Current, limited by T_{jmax} $T_C=25^\circ C$ value limited by bondwire $T_C=100^\circ C$	I_C	250 160	A
Diode Forward Current, limited by T_{jmax} $T_C=25^\circ C$ value limited by bondwire $T_C=100^\circ C$	I_F	250 160	A
Continuous Gate-Emitter Voltage	V_{GE}	± 20	V
Transient Gate-Emitter Voltage ($t_p \leq 10\mu s, D < 0.010$)	V_{GE}	± 30	V
Turn off Safe Operating Area $V_{CE} \leq 650V$, $T_j \leq 150^\circ C$		480	A
Pulsed Collector Current, $V_{GE}=15V$, t_p limited by T_{jmax}	I_{CM}	480	A
Diode Pulsed Current, t_p limited by T_{jmax}	I_{Fpuls}	480	A
Power Dissipation, $T_j=175^\circ C, T_C=25^\circ C$	P_{tot}	882	W



Operating Junction Temperature	T_j	-40...+175	°C
Storage Temperature	T_s	-55...+150	°C
Soldering Temperature, wave soldering 1.6mm (0.063in.) from case for 10s		260	°C

Electrical Characteristics of the IGBT ($T_j = 25^\circ\text{C}$ unless otherwise specified):

Parameter	Symbol	Conditions	Min.	Typ.	Max.	Unit
Static						
Collector-Emitter Breakdown Voltage	BV_{CES}	$V_{GE}=0V, I_C=250\mu A$	650		-	V
Gate Threshold Voltage	$V_{GE(th)}$	$V_{GE}=V_{CE}, I_C=3mA$	5.4	6.0	6.6	V
Collector-Emitter Saturation Voltage	$V_{CE(sat)}$	$V_{GE}=15V, I_C=160A$ $T_j=25^\circ\text{C}$, $T_j=125^\circ\text{C}$ $T_j=150^\circ\text{C}$	1.35	1.70 1.95 2.05	2.05	V
Zero Gate Voltage Collector Current	I_{CES}	$V_{CE}=650V, V_{GE}=0V$ $T_j=25^\circ\text{C}$, $T_j=150^\circ\text{C}$			0.25 3.00	mA
Gate-Emitter Leakage Current	I_{GES}	$V_{CE}=0V, V_{GE}=\pm 20V$			200	nA

Parameter	Symbol	Conditions	Min.	Typ.	Max.	Unit
Dynamic						
Input Capacitance	C_{ies}	$V_{CE}=25V, V_{GE}=0V,$ $f=1MHz$	-	9.88	-	nF
Reverse Transfer Capacitance	C_{res}		-	0.06	-	
Gate Charge	Q_G	$V_{CC}=300V, I_C=160A,$ $V_{GE}=-5V\sim+15V$	-	0.36	-	uC

**Electrical Characteristics of the Diode** ($T_j = 25^\circ\text{C}$ unless otherwise specified):

Parameter	Symbol	Conditions	Min.	Typ.	Max.	Unit
Static						
Diode Forward Voltage	V_F	$I_F = 160\text{A}$ $T_j = 25^\circ\text{C}$, $T_j = 125^\circ\text{C}$ $T_j = 150^\circ\text{C}$		1.55 1.50 1.45	2.05	V

Switching Characteristic, Inductive Load

Parameter	Symbol	Conditions	Min.	Typ.	Max.	Unit
Dynamic , at $T_j = 25^\circ\text{C}$						
Turn-on Delay Time	$t_{d(on)}$	$V_{CC} = 300\text{V}$, $I_C = 160\text{A}$, $V_{GE} = -5\text{V} \sim 15\text{V}$, $R_g = 10\Omega$ Inductive Load	-	135	-	ns
Rise Time	t_r		-	282	-	ns
Turn-on Energy	E_{on}		-	12.3	-	mJ
Turn-off Delay Time	$t_{d(off)}$		-	235	-	ns
Fall Time	t_f		-	97	-	ns
Turn-off Energy	E_{off}		-	4.4	-	mJ
Total switching energy	E_{ts}		-	16.7	-	mJ
Dynamic , at $T_j = 125^\circ\text{C}$						
Turn-on Delay Time	$t_{d(on)}$	$V_{CC} = 300\text{V}$, $I_C = 160\text{A}$, $V_{GE} = -5\text{V} \sim 15\text{V}$, $R_g = 10\Omega$ Inductive Load	-	139	-	ns
Rise Time	t_r		-	263	-	ns
Turn-on Energy	E_{on}		-	12.6	-	mJ
Turn-off Delay Time	$t_{d(off)}$		-	266	-	ns
Fall Time	t_f		-	144	-	ns
Turn-off Energy	E_{off}		-	5.9	-	mJ
Total switching energy	E_{ts}		-	18.5	-	mJ
Dynamic , at $T_j = 150^\circ\text{C}$						
Turn-on Delay Time	$t_{d(on)}$	$V_{CC} = 300\text{V}$, $I_C = 160\text{A}$, $V_{GE} = -5\text{V} \sim 15\text{V}$, $R_g = 10\Omega$ Inductive Load	-	142	-	ns
Rise Time	t_r		-	254	-	ns
Turn-on Energy	E_{on}		-	12.8	-	mJ
Turn-off Delay Time	$t_{d(off)}$		-	272	-	ns
Fall Time	t_f		-	181	-	ns
Turn-off Energy	E_{off}		-	6.5	-	mJ
Total switching energy	E_{ts}		-	19.3	-	mJ



Electrical Characteristics of the DIODE

Parameter	Symbol	Conditions	Min.	Typ.	Max.	Unit
Dynamic , at T_j= 25°C						
Reverse Recovery Current	I _{rr}	I _F =160A, V _R =300V -di/dt=340A/μs,	-	16	-	A
Reverse Recovery Charge	Q _{rr}		-	1.5	-	uC
Diode reverse recovery time	t _{rr}		-	142	-	ns
Reverse Recovery Energy	E _{rec}		-	0.10	-	mJ
Dynamic , at T_j= 125°C						
Reverse Recovery Current	I _{rr}	I _F =160A, V _R =300V -di/dt=340A/μs,	-	29	-	A
Reverse Recovery Charge	Q _{rr}		-	4.4	-	uC
Diode reverse recovery time	t _{rr}		-	213	-	ns
Reverse Recovery Energy	E _{rec}		-	0.41	-	mJ
Dynamic , at T_j= 150°C						
Reverse Recovery Current	I _{rr}	I _F =160A, V _R =300V -di/dt=340A/μs,	-	38	-	A
Reverse Recovery Charge	Q _{rr}		-	6.1	-	uC
Diode reverse recovery time	t _{rr}		-	248	-	ns
Reverse Recovery Energy	E _{rec}		-	0.46	-	mJ

Thermal Resistance

Parameter	Symbol	Max. Value	Unit
IGBT Thermal Resistance, Junction - Case	R _{th(j-c)}	0.17	K/W
Diode Thermal Resistance, Junction - Case	R _{th(j-c)}	0.25	K/W
Thermal Resistance, Junction - Ambient	R _{th(j-a)}	40	K/W

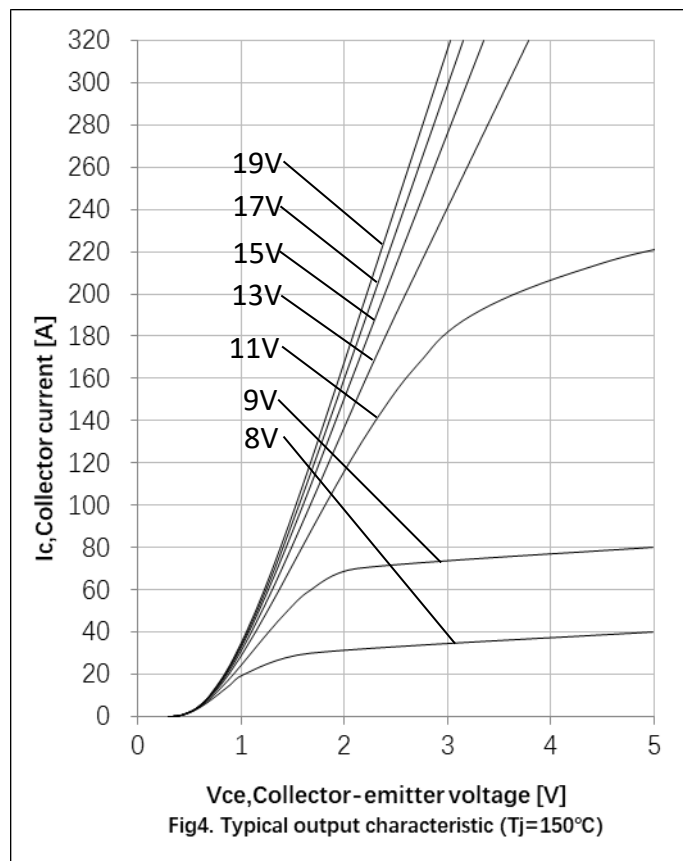
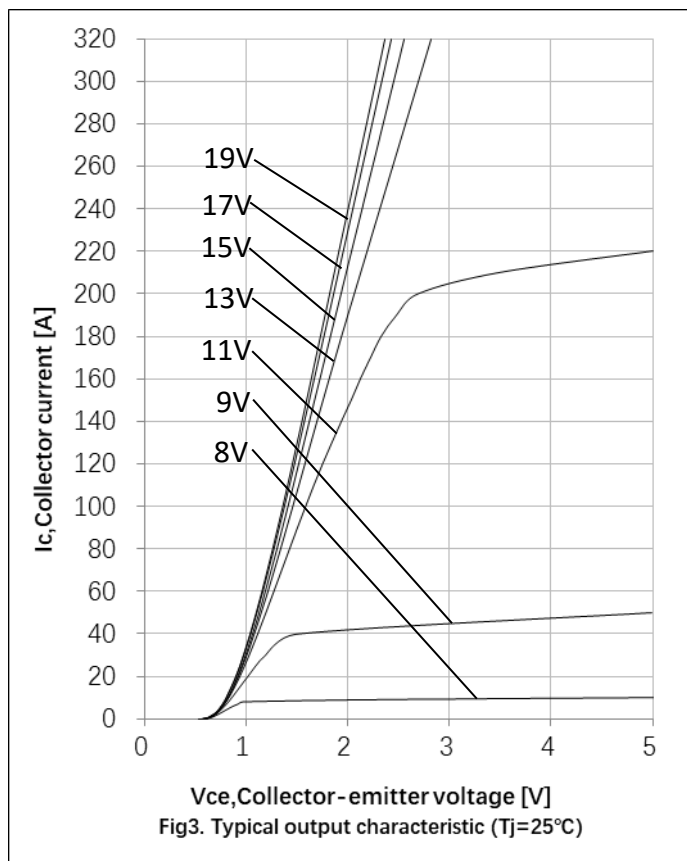
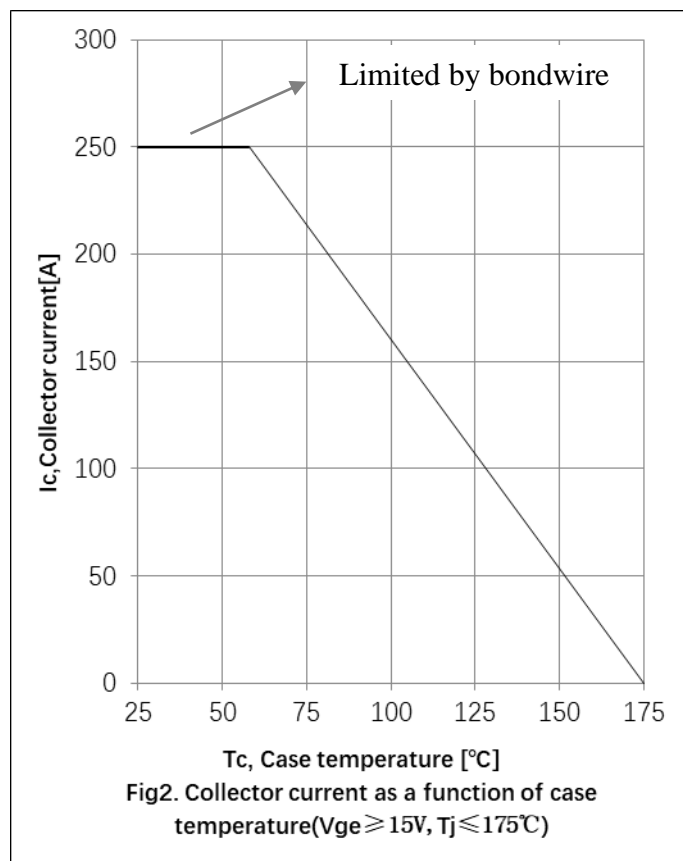
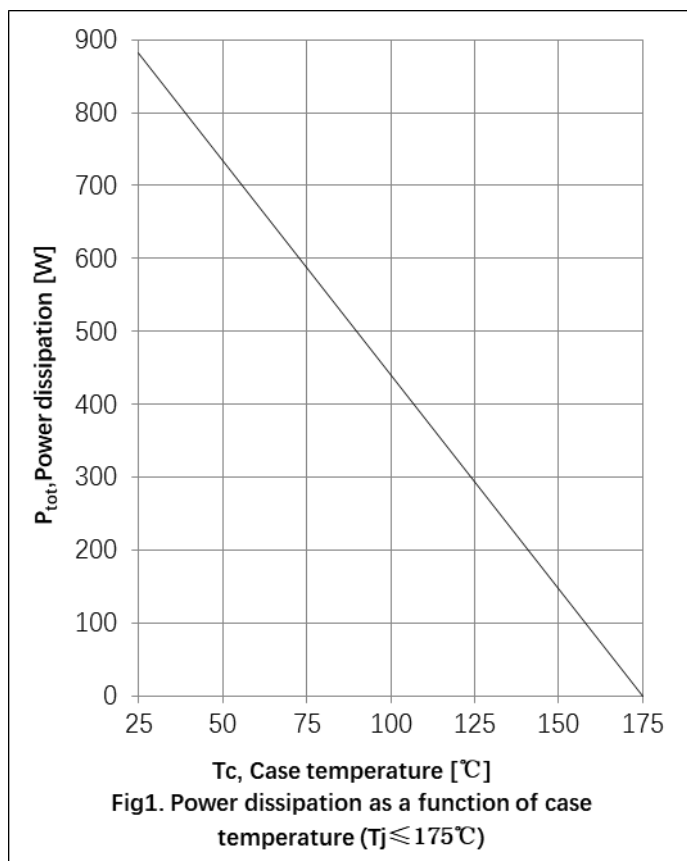

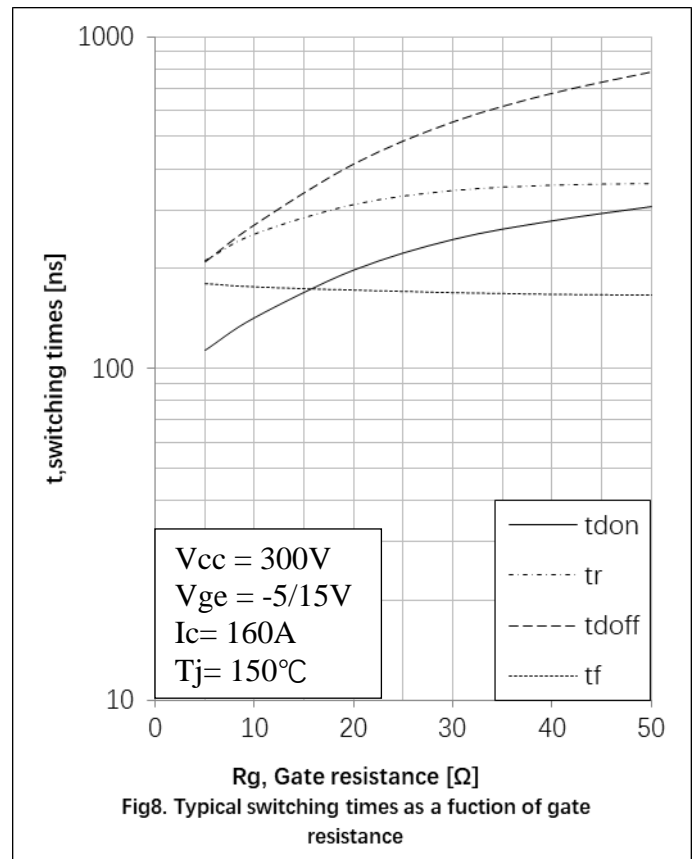
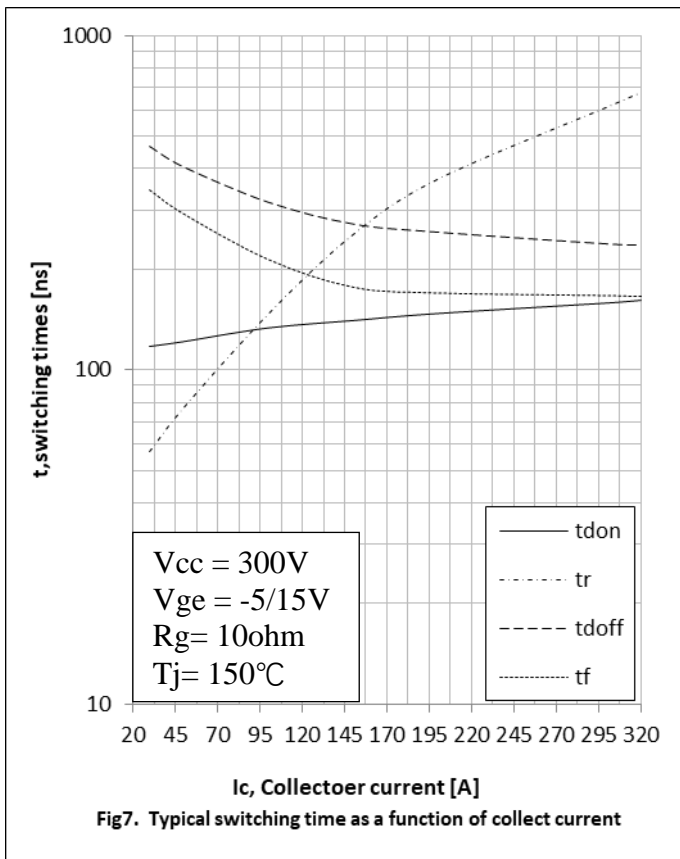
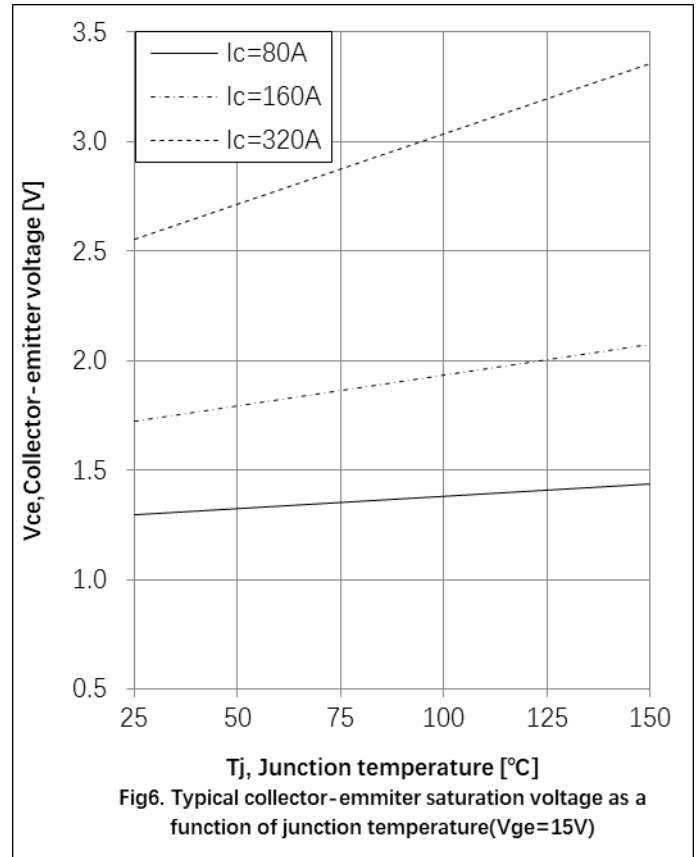
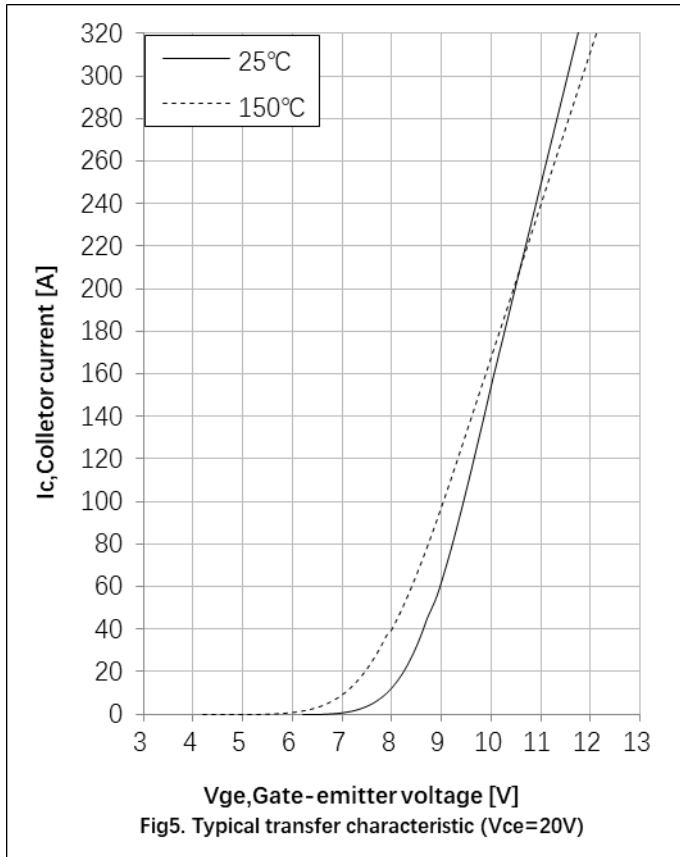

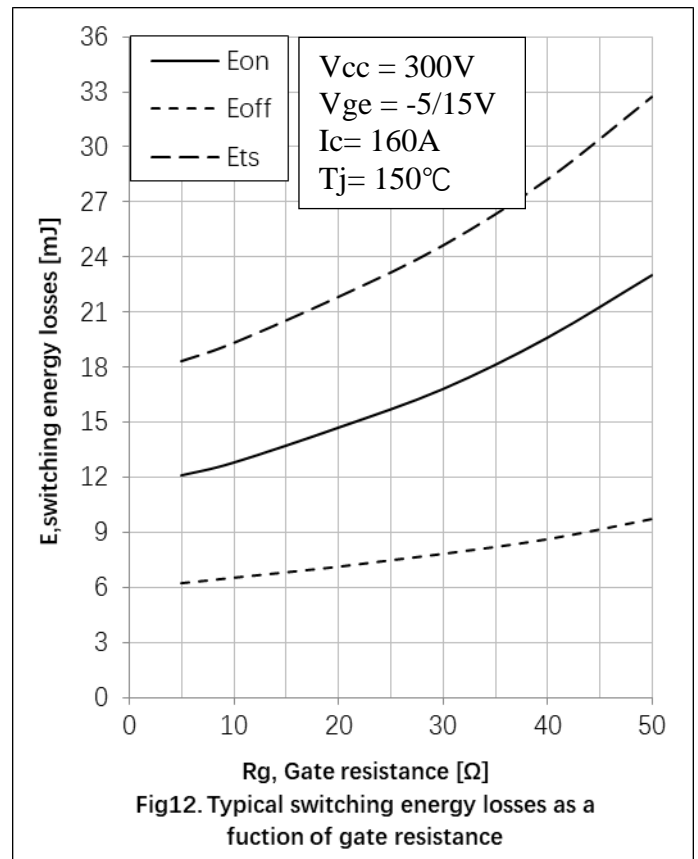
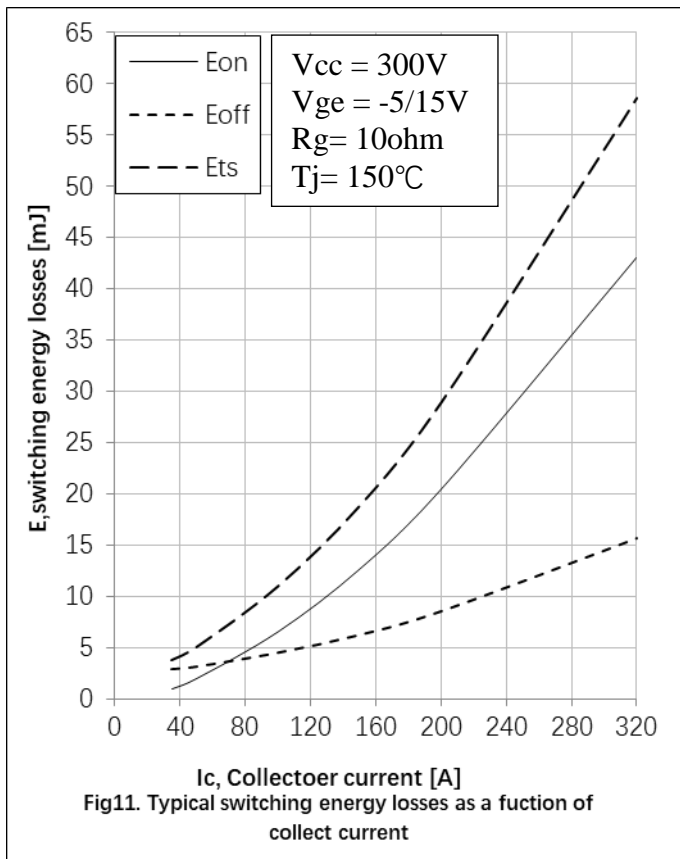
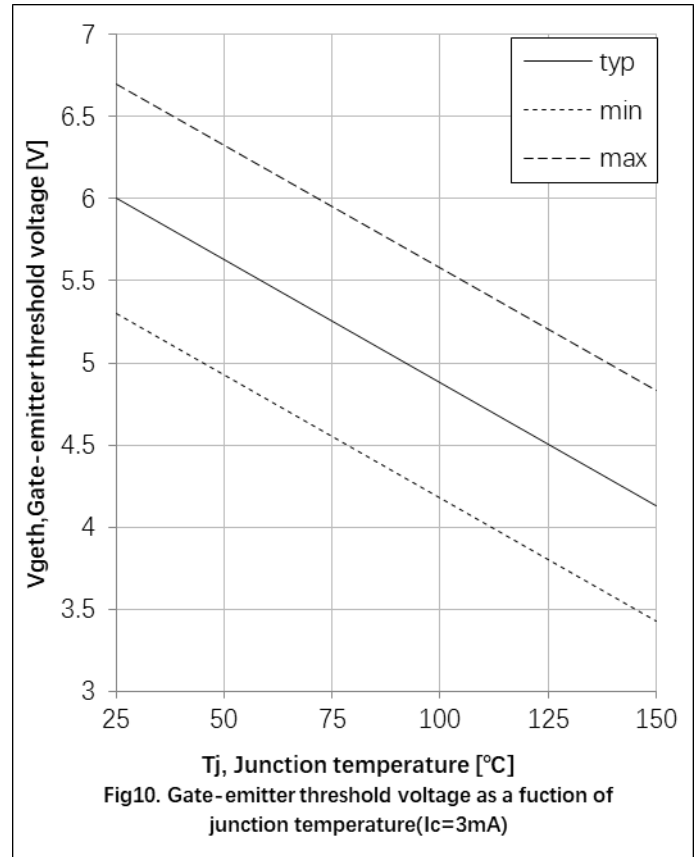
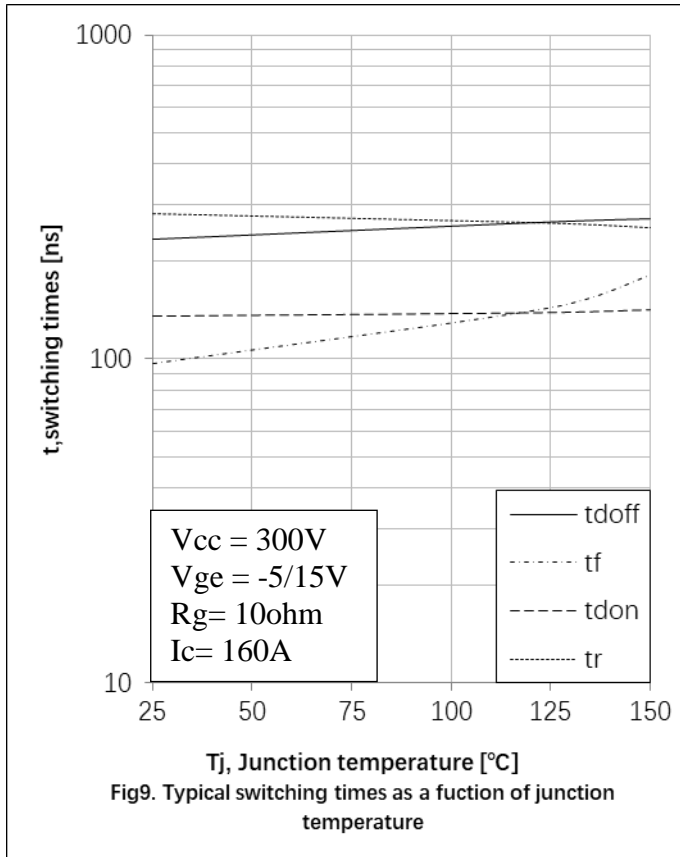

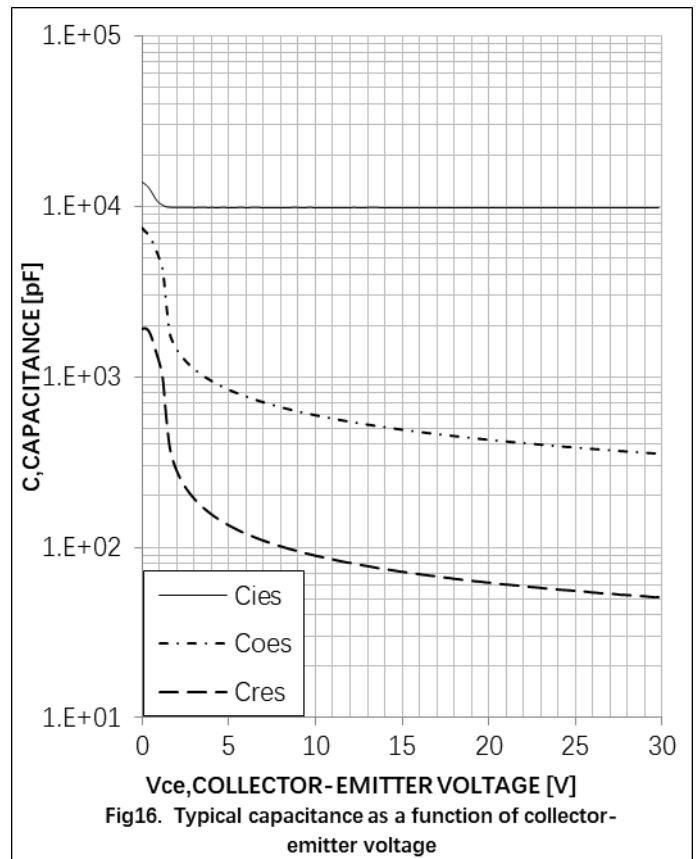
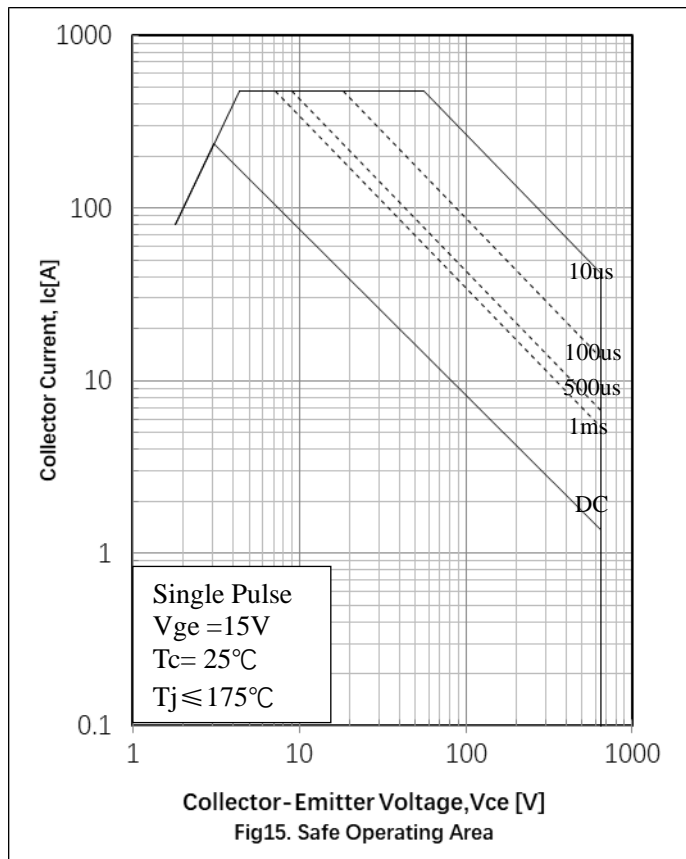
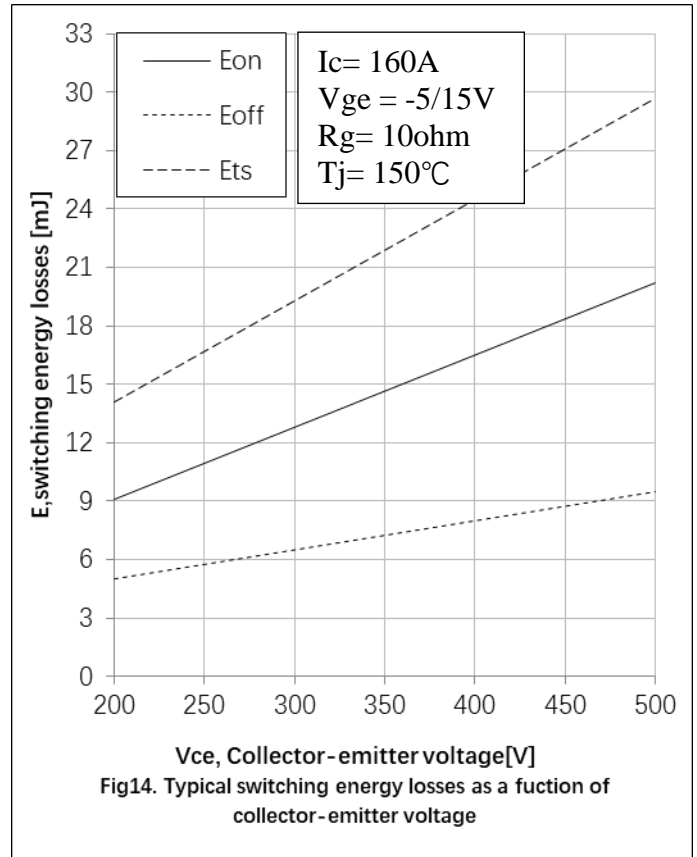
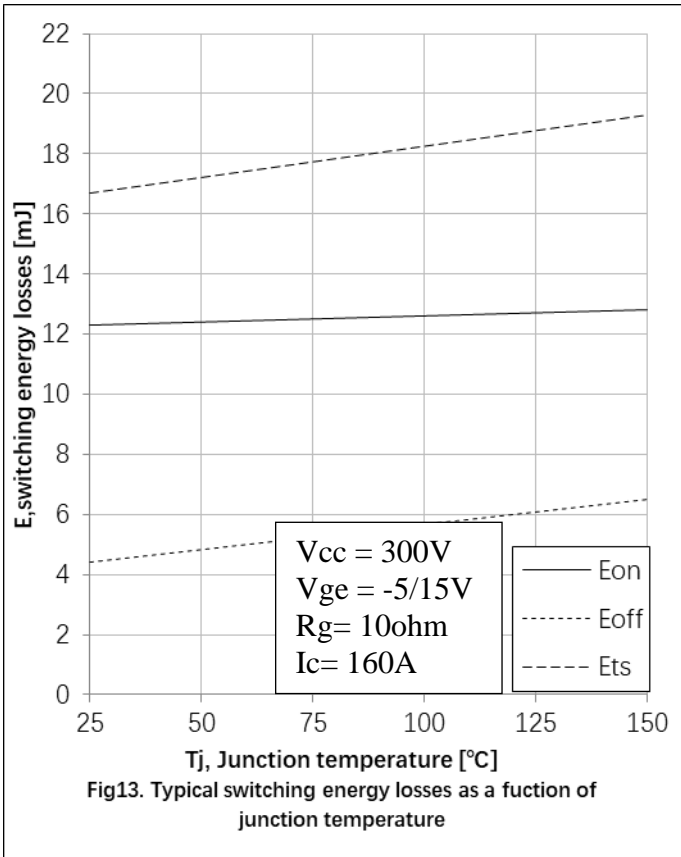

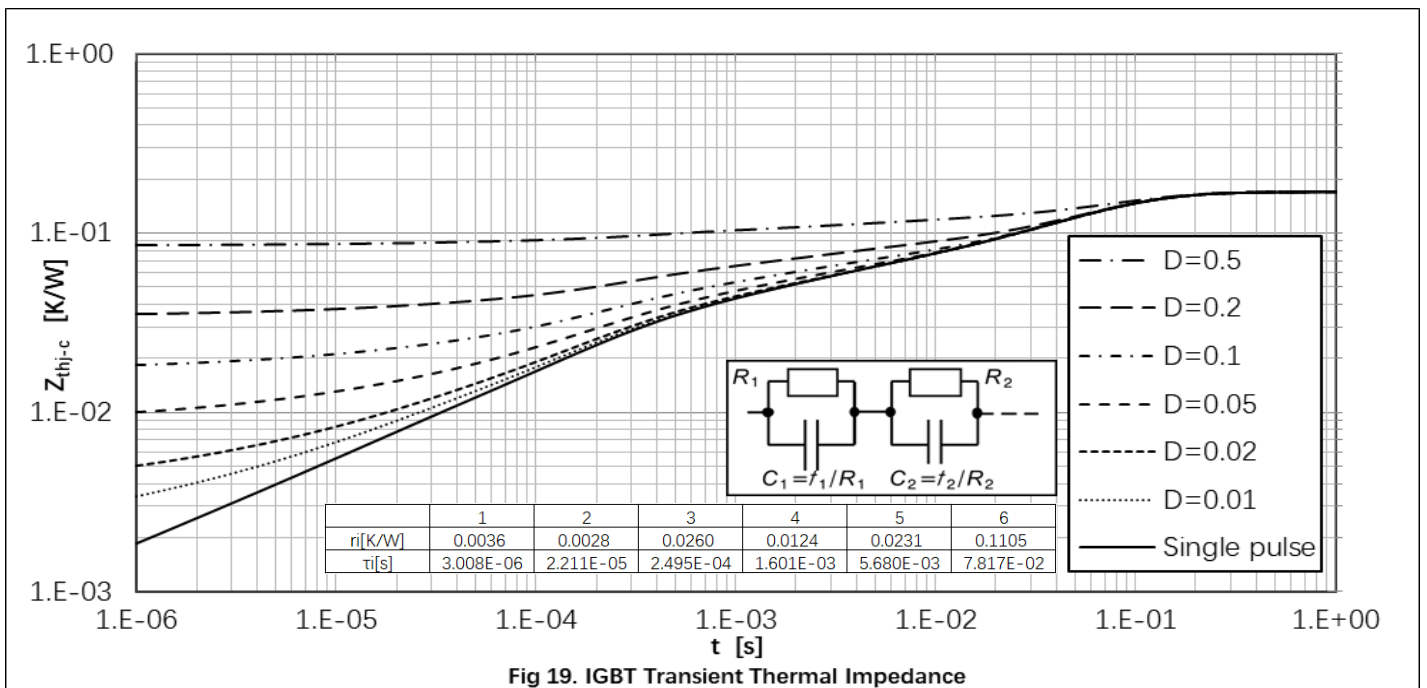
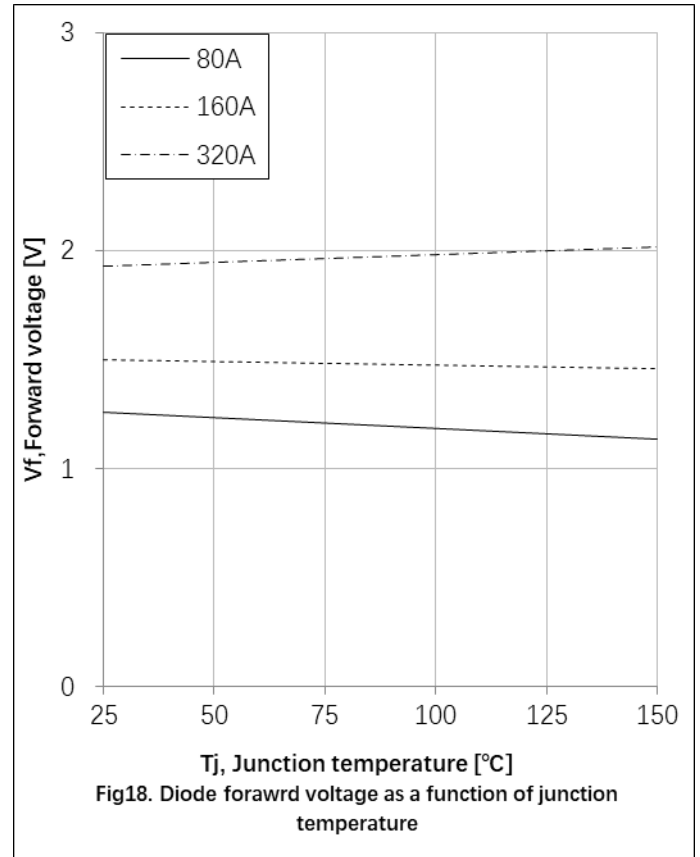
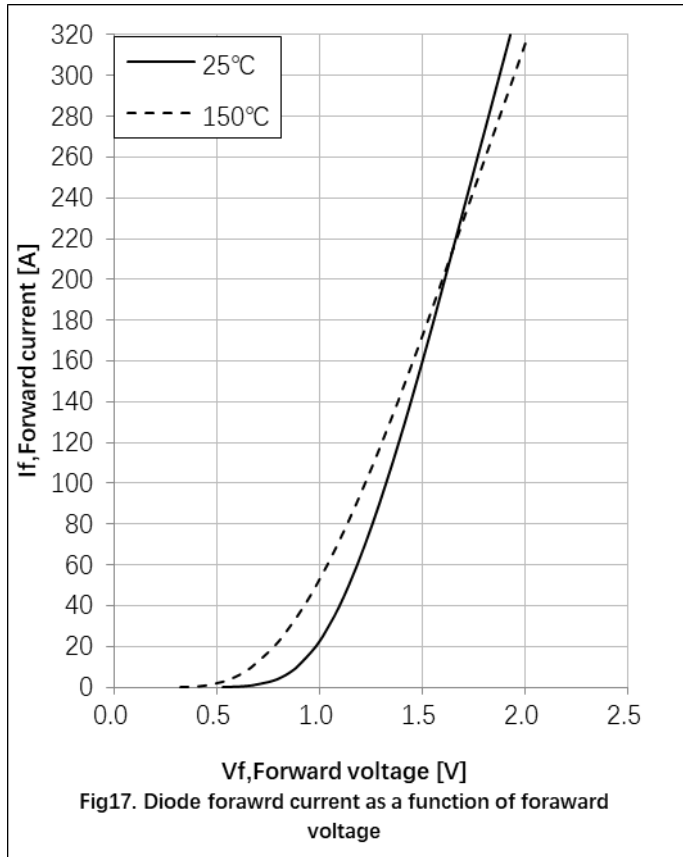

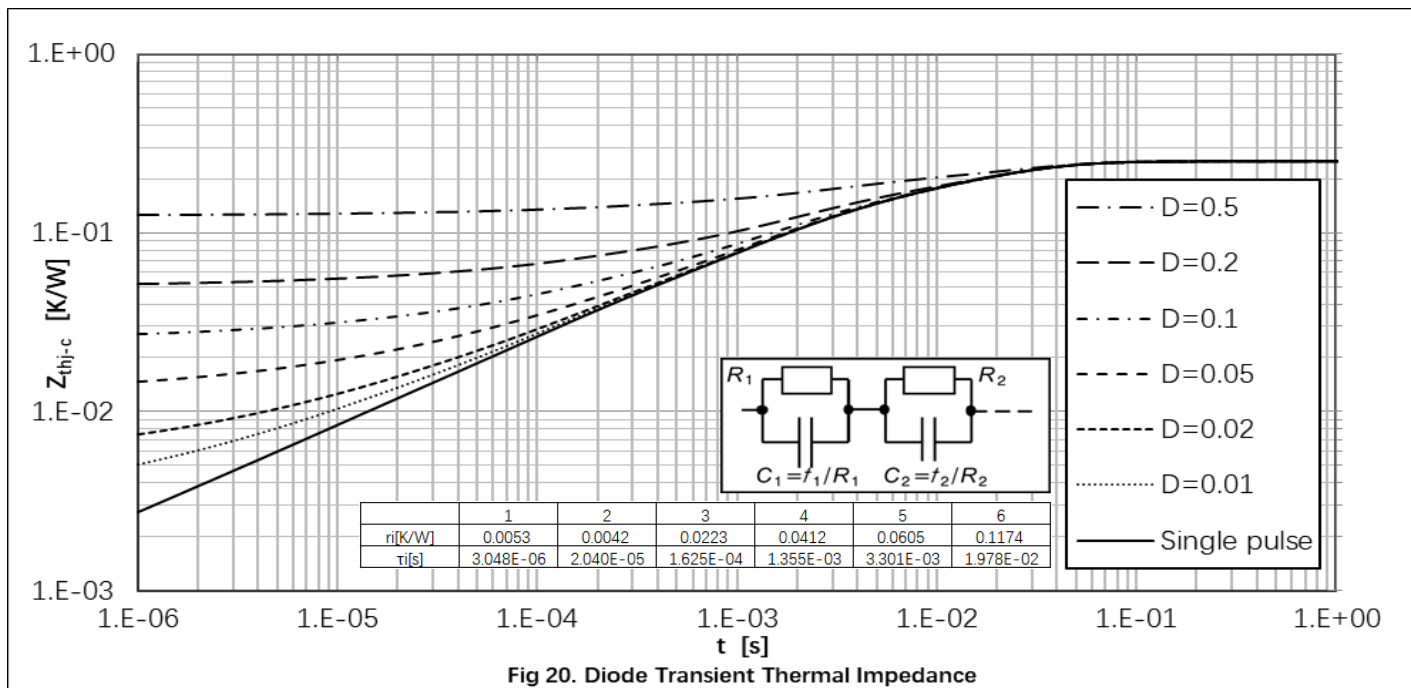

Circuit Diagram

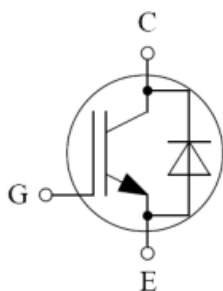

● Package Outline Information

CASE: TO 247plus

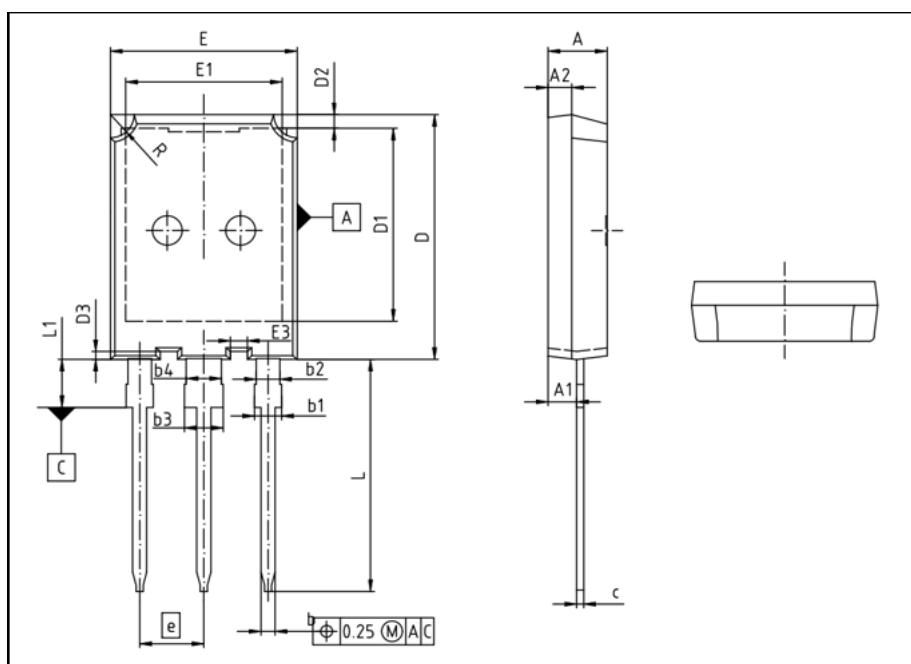

DIM	MILLIMETERS	
	MIN	MAX
A	4.90	5.10
A1	2.31	2.51
A2	1.90	2.10
b	1.16	1.26
b1	1.86	2.16
b2	1.96	2.06
c	0.58	0.64
D	20.90	21.10
D1	16.25	16.85
D2	1.05	1.35
D3	0.58	0.78
E	15.70	15.90
E1	13.10	13.50
E3	1.35	1.55
e	5.44(BSC)	
L	19.78	20.08
L1	4.03	4.23
R	1.90	2.10