

N-Channel Enhancement Mode Field Effect Transistor

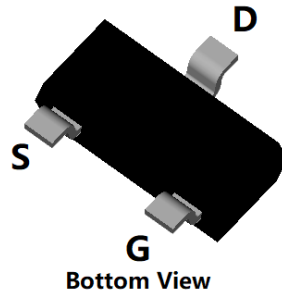

SOT-23

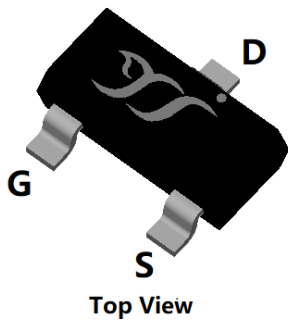
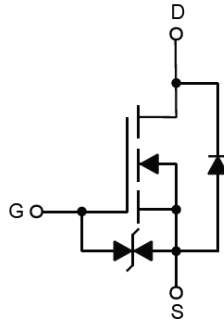

Product Summary

- V_{DS} 60V
- I_D 300mA
- $R_{DS(ON)}$ (at $V_{GS}=10V$) <2.5ohm
- $R_{DS(ON)}$ (at $V_{GS}=4.5V$) <3.0ohm
- Gate-Source ESD Rating Up to 2KV (HBM)

General Description

- Trench Power MV MOSFET technology
- Voltage controlled small signal switch
- Low input Capacitance
- Fast Switching Speed
- Low Input / Output Leakage
- Part no. with suffix "Q" means AEC-Q101 qualified

Applications

- Battery operated systems
- Solid-state relays
- Direct logic-level interface: TTL/CMOS

■ Absolute Maximum Ratings ($T_A=25^\circ\text{C}$ unless otherwise noted)

| Parameter | Symbol | Limit | Unit |
|--|-----------------|---------------------------------------|---------------------------|
| Drain-source Voltage | V_{DS} | 60 | V |
| Gate-source Voltage | V_{GS} | ± 20 | V |
| Drain Current | I_D | $T_A=25^\circ\text{C}$ @ Steady State | 300 |
| | | $T_A=70^\circ\text{C}$ @ Steady State | 240 |
| Pulsed Drain Current ^A | I_{DM} | 1.5 | A |
| Total Power Dissipation @ $T_A=25^\circ\text{C}$ | P_D | 300 | mW |
| Thermal Resistance Junction-to-Ambient @ Steady State ^B | $R_{\theta JA}$ | 416 | $^\circ\text{C}/\text{W}$ |
| Junction and Storage Temperature Range | T_J, T_{STG} | -55~+150 | $^\circ\text{C}$ |

■ Ordering Information (Example)

| PREFERRED P/N | PACKING CODE | Marking | MINIMUM PACKAGE(pcs) | INNER BOX QUANTITY(pcs) | OUTER CARTON QUANTITY(pcs) | DELIVERY MODE |
|---------------|--------------|---------|----------------------|-------------------------|----------------------------|---------------|
| 2N7002KCQ | F2 | 72KC. | 3000 | 30000 | 120000 | 7" reel |



2N7002KCQ

■ Electrical Characteristics (T_J=25°C unless otherwise noted)

| Parameter | Symbol | Conditions | Min | Typ | Max | Units |
|---------------------------------------|---------------------|--|-----|------|-----|-------|
| Static Parameter | | | | | | |
| Drain-Source Breakdown Voltage | BV _{DSS} | V _{GS} = 0V, I _D =250μA | 60 | | | V |
| Zero Gate Voltage Drain Current | I _{DSS} | V _{DS} =60V, V _{GS} =0V, T _J =25°C | | | 1 | μA |
| | | V _{DS} =60V, V _{GS} =0V, T _J =125°C | | | 10 | μA |
| | | V _{DS} =50V, V _{GS} =0V, T _J =25°C | | | 100 | nA |
| Gate-Body Leakage Current | I _{GSS} | V _{GS} = ±20V, V _{DS} =0V | | | ±10 | μA |
| Gate Threshold Voltage | V _{GS(th)} | V _{DS} = V _{GS} , I _D =250μA | 1 | 1.5 | 2.5 | V |
| Static Drain-Source On-Resistance | R _{DS(on)} | V _{GS} = 10V, I _D =300mA | | 1.9 | 2.5 | Ω |
| | | V _{GS} = 4.5V, I _D =200mA | | 2.0 | 3.0 | |
| Diode Forward Voltage | V _{SD} | I _S =300mA, V _{GS} =0V | | | 1.2 | V |
| Maximum Body-Diode Continuous Current | I _S | | | | 300 | mA |
| Dynamic Parameters | | | | | | |
| Input Capacitance | C _{iss} | V _{DS} =30V, V _{GS} =0V, f=1MHZ | | 27 | | pF |
| Output Capacitance | C _{oss} | | | 3 | | |
| Reverse Transfer Capacitance | C _{rss} | | | 2 | | |
| Switching Parameters | | | | | | |
| Total Gate Charge | Q _g | V _{GS} =10V, V _{DS} =30V, I _D =0.3A | | 1.65 | 2.4 | nC |
| Turn-on Delay Time | t _{D(on)} | V _{GS} =10V, V _{DD} =30V, I _D =300mA, R _{GEN} =6Ω | | 6.5 | | ns |
| Turn-off Delay Time | t _{D(off)} | | | 9.6 | | |
| Reverse recovery Time | t _{rr} | V _{GS} =0V, I _S =300mA, V _R =25V, di/dt=-100A/μs | | 24 | | ns |

A. Pulse Test: Pulse Width ≤ 300us, Duty cycle ≤ 2%.

B. Device mounted on FR-4 PCB, 1 inch x 0.85 inch x 0.062 inch.



■ Typical Performance Characteristics

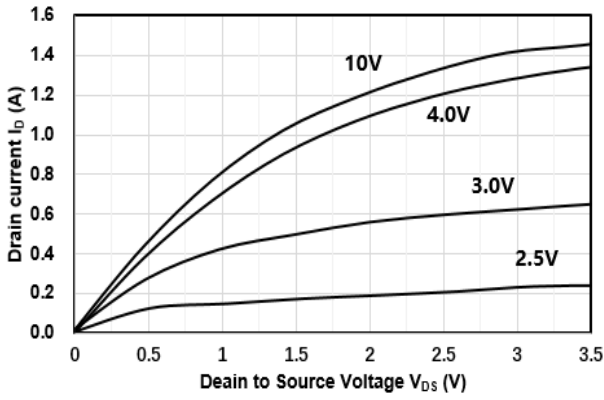

Figure1. Output Characteristics

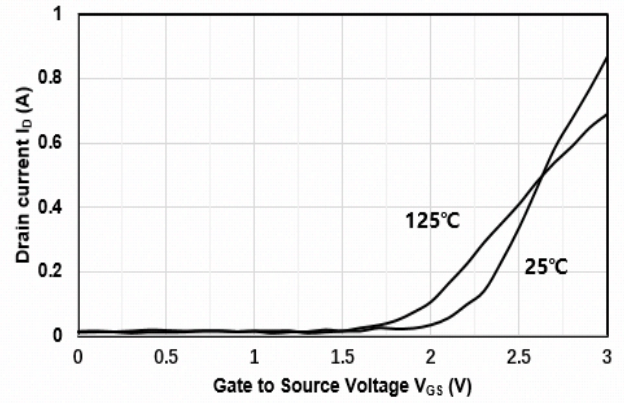

Figure2. Transfer Characteristics

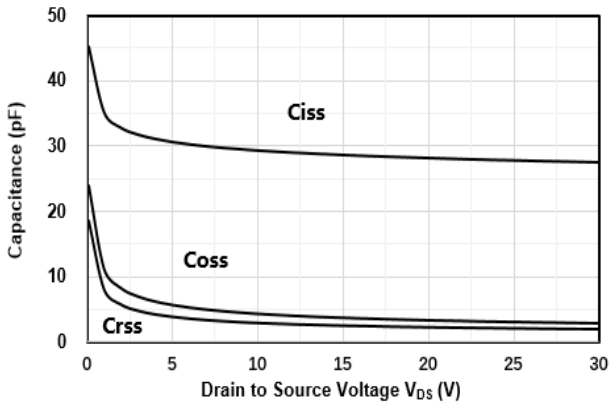

Figure3. Capacitance Characteristics

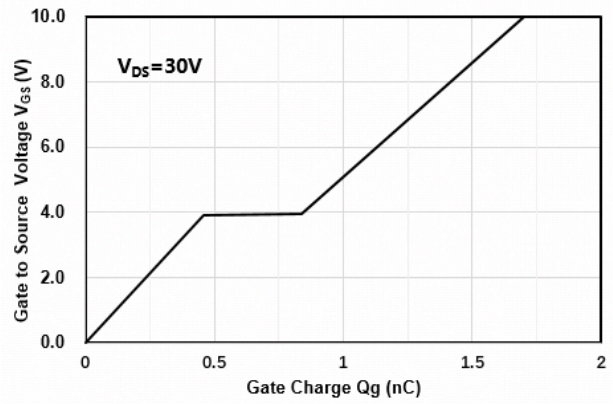

Figure4. Gate Charge

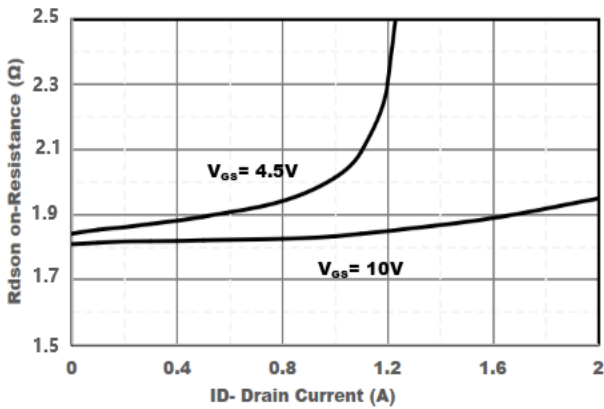

Figure5. Drain-Source on Resistance

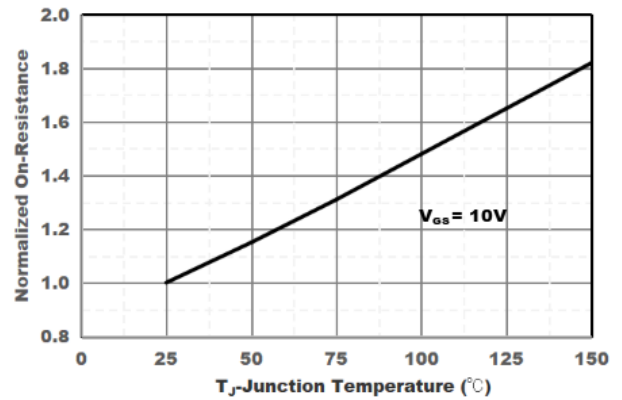

Figure6. Drain-Source on Resistance



2N7002KCQ

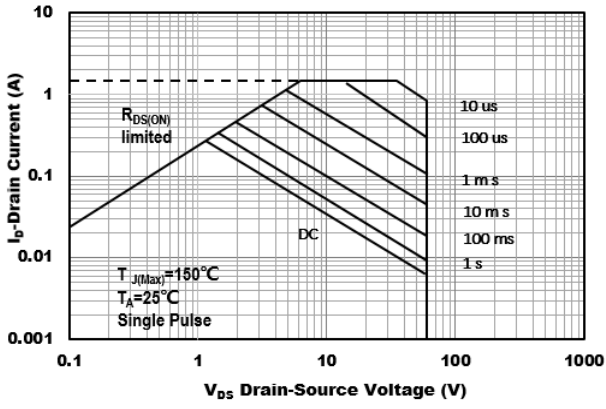

Figure7. Safe Operation Area

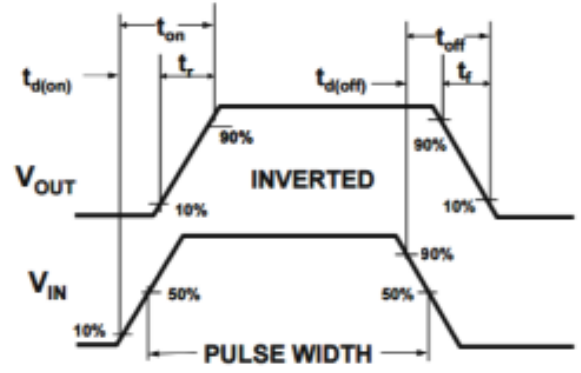
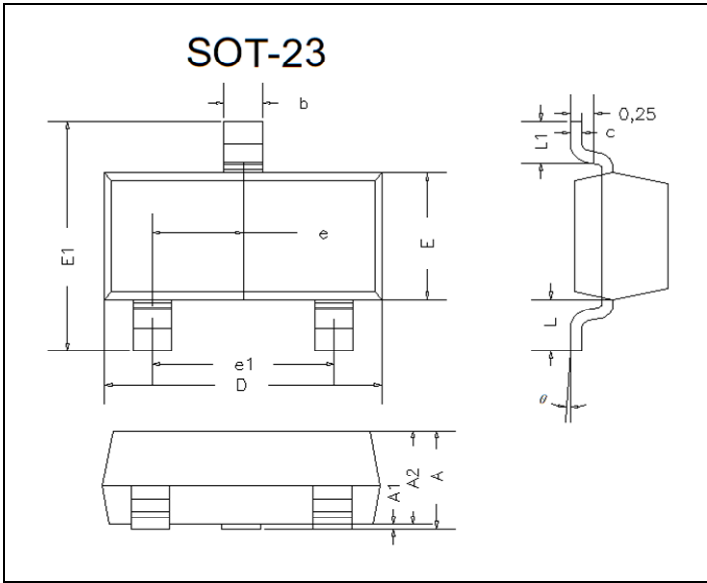

Figure8. Switching wave



2N7002KCQ

■ SOT-23 Package information



| DIM | INCHES | | MM | | NOTE |
|-----|----------|-------|---------|------|------|
| | MIN | MAX | MIN | MAX | |
| A | 0.035 | 0.045 | 0.90 | 1.15 | |
| A1 | 0.000 | 0.004 | 0.00 | 0.10 | |
| A2 | 0.035 | 0.041 | 0.90 | 1.05 | |
| b | 0.012 | 0.020 | 0.30 | 0.50 | |
| c | 0.004 | 0.008 | 0.10 | 0.20 | |
| D | 0.110 | 0.118 | 2.80 | 3.00 | |
| E | 0.047 | 0.055 | 1.20 | 1.40 | |
| E1 | 0.089 | 0.100 | 2.25 | 2.55 | |
| e | 0.370TYP | | 0.95TYP | | |
| e1 | 0.071 | 0.079 | 1.80 | 2.00 | |
| L | 0.220REF | | 0.55REF | | |
| L1 | 0.012 | 0.020 | 0.30 | 0.50 | |
| θ | 0° | 8° | 0° | 8° | |

■ SOT-23 Suggested Pad Layout

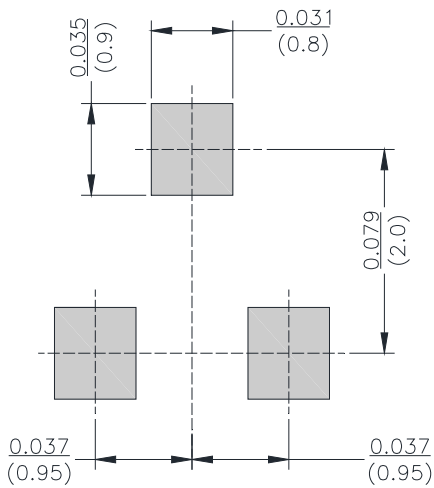



2N7002KCQ

Disclaimer

The information presented in this document is for reference only. Yangzhou Yangjie Electronic Technology Co., Ltd. reserves the right to make changes without notice for the specification of the products displayed herein to improve reliability, function or design or otherwise.

The product listed herein is designed to be used with automotive electronics, are not designed for use in medical, life-saving, lifesustaining, or military, Yangjie or anyone on its behalf, assumes no responsibility or liability for any damages resulting from such improper use of sale.

This publication supersedes & replaces all information previously supplied. For additional information, please visit our website [http:// www.21yangjie.com](http://www.21yangjie.com) , or consult your nearest Yangjie's sales office for further assistance.